

Article number: 54301325

Description: LDK Rod end PHS 25

Measures

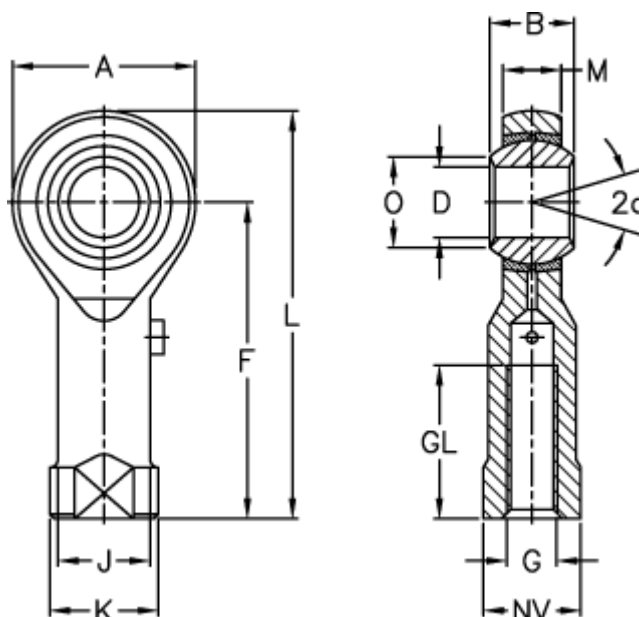

A	= 60	J	= 33.5
a (degrees)	= 15	K	= 42
B	= 31	L	= 124
D	= 25	M	= 22.00
Dynamic load C (kN)	= 40.5	NV	= 36
F	= 94	O	= 29.50
g	= M24x2	Static load C0 (kN)	= 68.0
GL	= 48	Weight (g)	= 750.0